

云天模塑

Huangyan Yuntian Mould & Plastic Co., Ltd



黄岩云天模塑有限公司

HUANGYAN YUNTIAN MOULD & PLASTIC CO., LTD .



专业
Professional

诚信
Integrity

创新
Innovation

发展
Development

【企业简介】

黄岩云天模塑有限公司是致力于设计制造各类塑料模具的专业企业，主要从事摩托车类模具、汽车模具、齿轮模具、日用品模具、家用电器模具（空调、洗衣机、电冰箱）等开发与设计。

公司现拥有国际先进水平的生产设备和高素质员工。完善的CAS-CAD-CAE-CAM-CAQ全套流程，为用户提供快捷、准确的服务；意大利“菲迪亚”高速加工中心等精密加工设备及各种检测系统是生产优质产品的保障；专业的技术人员是模具的设计制作的核心，擅长于热流道、双色注塑模具、流动及成型缺陷分析、模具加工预补偿、快速成型等技术。

公司秉承“高起点，高标准，高质量，高效益”的宗旨，与国内外众多企业结成战略同盟。韩国现代、长春一汽、日本索尼、以色列Only Domestic clients、意大利、中东等客户取得长期合作。自公司成立至今，以优质的产品和服务立足于模具行业，不断的完善管理。

我们的专业，值得您信赖！期待与您合作！

INTRODUCTION

Huangyan Yuntian Mould & Plastic Co., Ltd is professional in manufacturing plastic molds, we mainly producing Automotive molds, Electrical Appliance molds and Commodity molds etc.

We possess of advanced equipments including Italy "FIDA" Milling machine, and a sophisticated technology team. An overall CAS/CAD/CAE/CAM/CAQ system is applied in designing and manufacturing to meet customers' demands. We are also engaged in hot runner, double colored mold, mold flow, rapid prototype etc.

We take "High starting, High standard, High quality, High effective" as our tenet. After years' development, we have established long-term business with Sony、Faw-Volkswagen、and many companies in Israel, Italy, and Mid-East.

We believe our specialty and quality will guarantee our further cooperation.



*The company is **ISO9001** certified.*

The company is ISO9001 certified, we not only pay attention to quality guarantee, but also emphasize the quality management. To think about profit, cost and venture, we adopt an effective method to control and prevent various quality disadvantages, and try our best to satisfy every customers.

模具流程

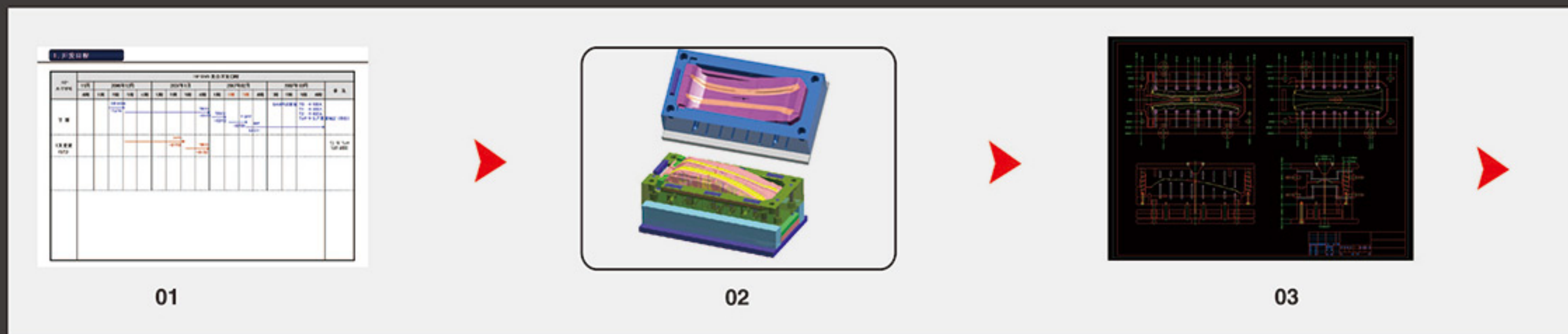

the quality goes in before the name goes on.

1. Mould manufacture standard documents will be done by Engineering Dept and we will have a meeting for the new mould.
2. Mould design: 3D, 2D drawing designed according to customers' requests and standards.
3. After mould design confirmed, We will order the steel and mould base tooling. In the meantime, sending customer the tooling & processing schedule.
4. Mould components purchasing and preparation.
5. Sending the mould situation to customer by photos weekly. QC Dept following the mould processing schedule closely, controlling the mould quality strictly.
6. Checking the mould: polishing, texture, logo, waterline and so on.
7. Assembling.
8. Mould first testing, checking the part dimension, and work out the inspection report documents.
9. Sending the samples and inspection report to customer.
10. Customer instruction & confirmation for shipment.



MOULD PRODUCING FLOW CHART

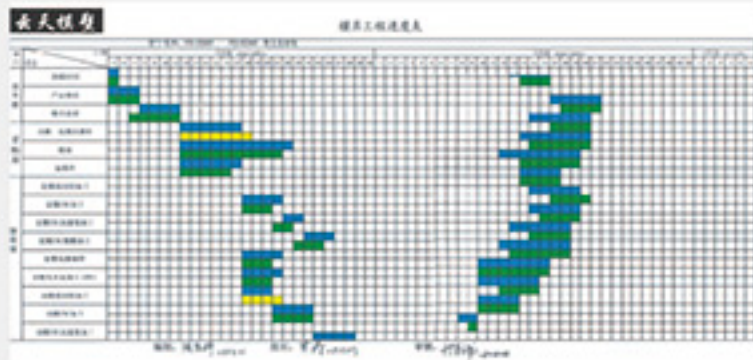

04

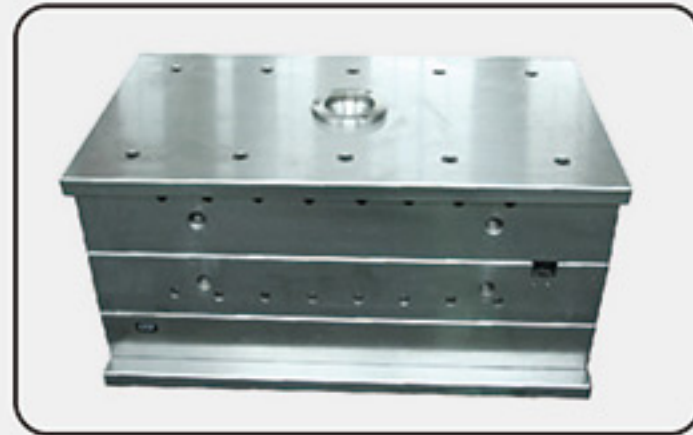

05

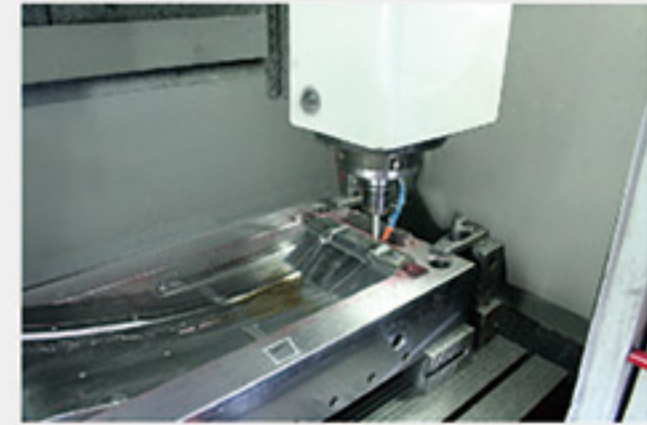

06



09



Injection of Technics List

Item No.	Part Name	Material	Quantity	Unit	Remarks
1
2
3
4
5
6
7
8
9
10
11
12
13
14
15
16
17
18
19
20
21
22
23
24
25
26
27
28
29
30
31
32
33
34
35
36
37
38
39
40
41
42
43
44
45
46
47
48
49
50

08



07

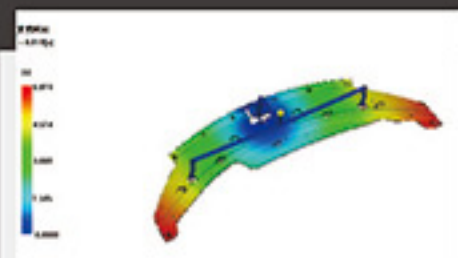

MPI/Fill time
通过模拟注塑成型的时间，
以预测产品完全成型所需的时间。
By simulating injection molding processes,
we can predict the time needed
for making a product.

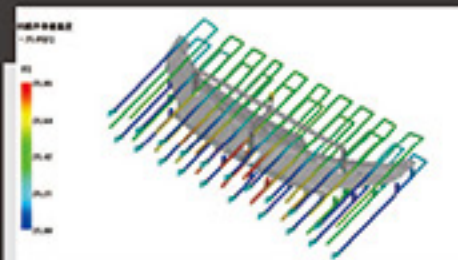

MPI/cool
冷却水。Cooling water.
通过模拟注塑成型过程来优化产品的温度分布，
从而控制产品表面质量。
By simulating injection moulding process
to adjust temperature distribution on the
products, and furthermore ensure products
surface quality.



MPI/Weld Line
通过模拟接线缝产生过程，在模具设计过程中
避免接线缝的产生。
By simulating the forming of welding line,
we try to avoid it early in mould design.



MPI/Air Traps:
通过模拟注塑辅助排气系统
的设计，提高工作效率。
By simulating assisted gas extraction
system in injection,
we can improve working efficiency.

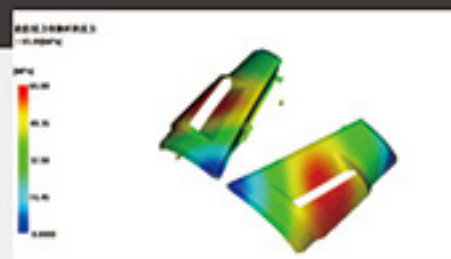

MPI/Pressure:
通过模拟成型过程观察产品各部分压力
大小，保证各部分成型所需压力。
By simulating injection process, we
learned pressure of different part of
the product, so we can adjust proper
pressure in different part.



MPI/Temperature:
通过模拟注塑成型过程中产品各部分的
温度，以预测可能出现变形的区域。
By simulating products temperature in
injection molding process, we can predict
the possible distortion area of the products.

云天模具工程师经验丰富，具有综合开发理念。工程师们非常重视模具制作工序，精心设计，力图打造具有使用年限最长维修次数少的模具。

Mold engineering designers of Yuntian, which have rich experience in comprehensive development concept. The engineers attach great importance to the mold production process, the design, trying to make with the longest use and fewer maintenance of mold.

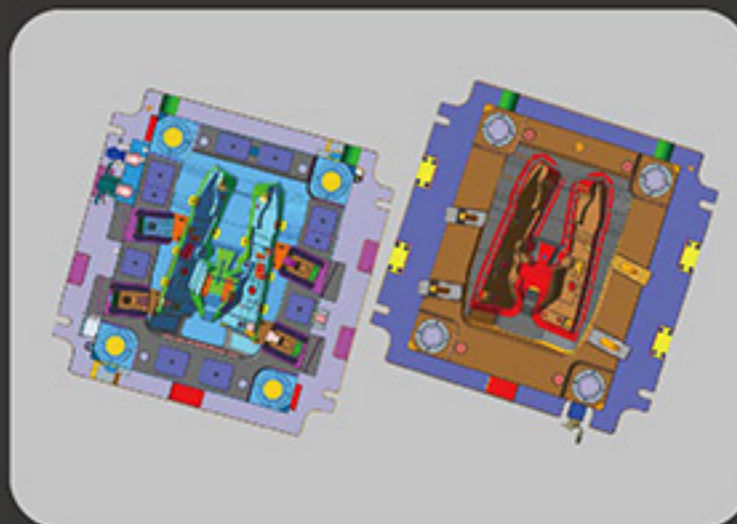
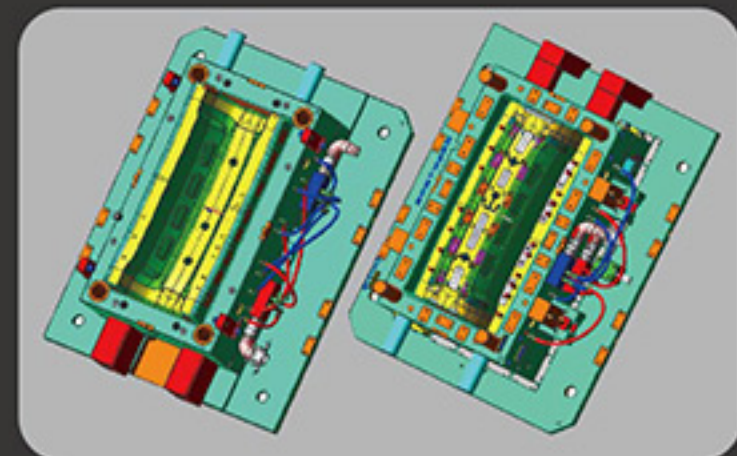
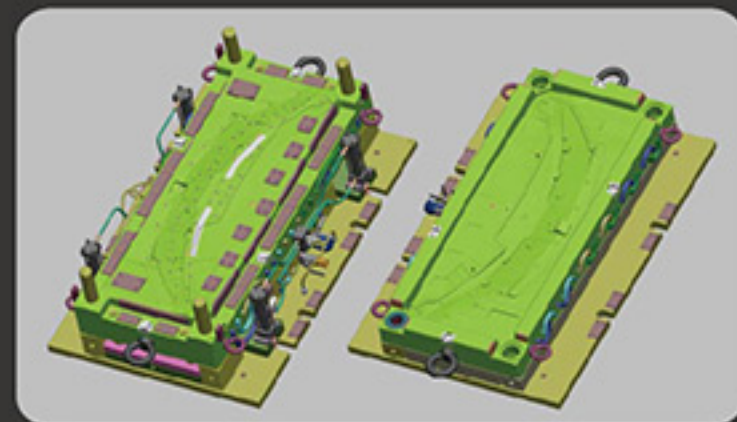
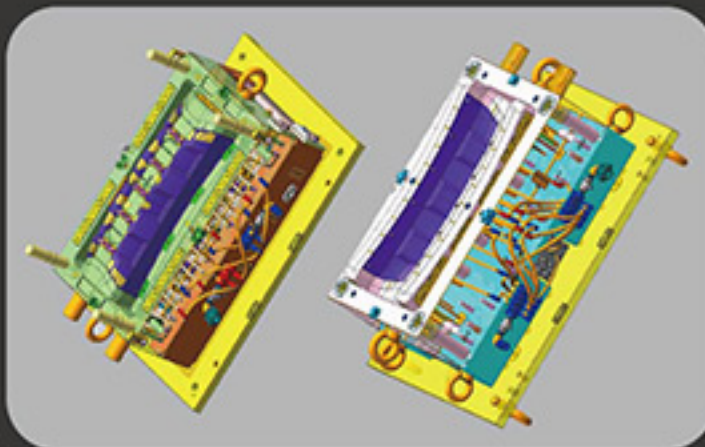
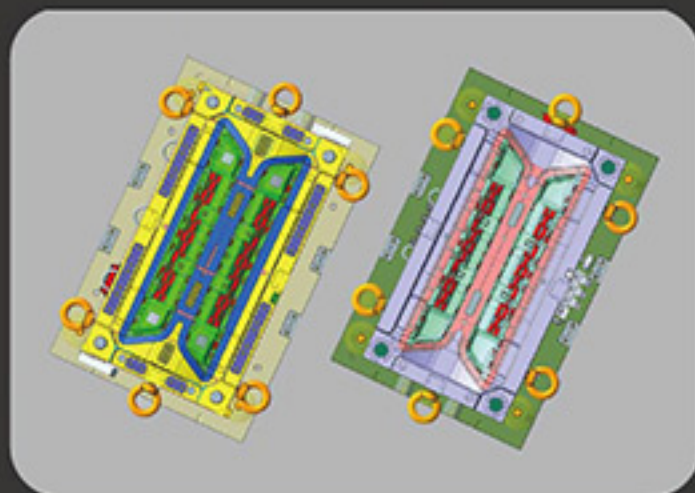
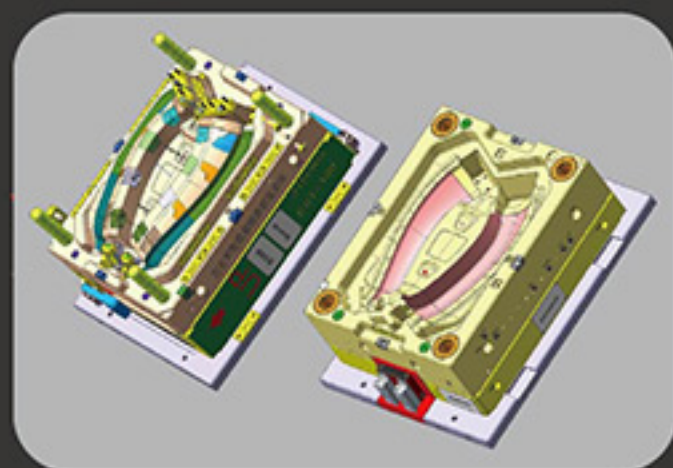

equipment

生产设备

工欲善其事，必先利其器

Right tool for the right job





Huangyan Yuntian Mould & Plastic Co., Ltd is professional in manufacturing plastic molds, we mainly producing Automotive molds, Electrical Appliance molds and Commodity molds etc.

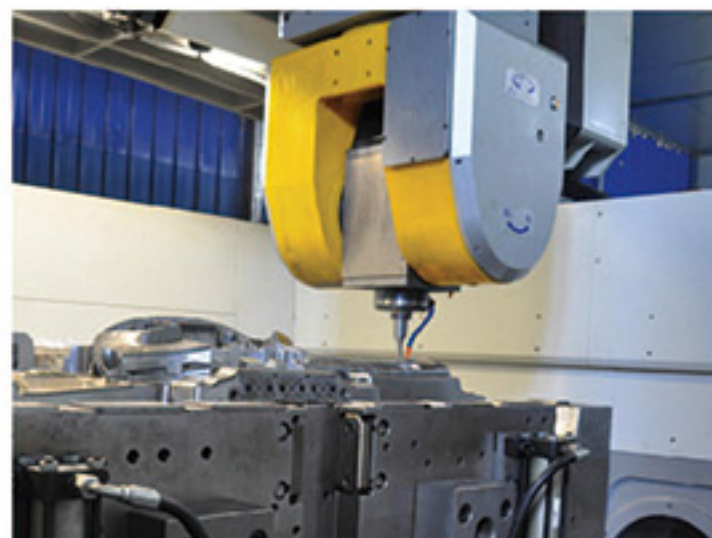

Item name	Specification	Origin	Quantity
电火花 EDM	DK7740	HangZhou	5
合模机 Die-spotting Machine	LS-200T	NingBo	1
钻孔 Drilling Machine		HangZhou	4
精密平面磨床 Precision Horizontal Surface Grinding Machine	KGS-250	TaiWan	2
硬度计 Hardness Tester	Testing Equipment	China	2
三坐标测量机 Coordinate Measuring Machine	KRONOS30-15-13	Italy	1

设备 MACHINE	有效加工范围 Working range	设备定位精度 Machine positioning accuracy	工件加工精度 Work-piece machining precision	主轴转速 Max spindle speed
数控铣 CNC Milling Machine	2600mm * 1900mm * 1100mm 1500mm * 800mm * 700mm 1000mm * 600mm * 500mm	0.002mm	0.02mm	0-6000rpm
高速加工中心 HSM	1200mm * 800mm * 500mm	0.001mm	0.01mm	0-24000rpm
电脉冲 Electric Discharge Machine	4000mm * 1700mm * 1000mm	0.002mm	0.02mm	---
线切割 Wire EDM	700mm * 450mm * 500mm	0.01mm	0.02mm	---
慢走丝线切割 Low speed Wire EDM	600mm * 400mm * 350mm	0.001mm	0.002mm	---
深孔钻 Deep-hole driller	2400mm * 1500mm * 1200mm	0.01mm	0.02mm	0-6000rpm

automobile mould

汽车模具

- 转向灯罩模具 Steering lampshade mold
- 保险杠模具 Bumper mold
- 座椅模具 Seat mold



other mould

双色模具



YUNTIAN MOULD & PLASTICS CO., LTD.

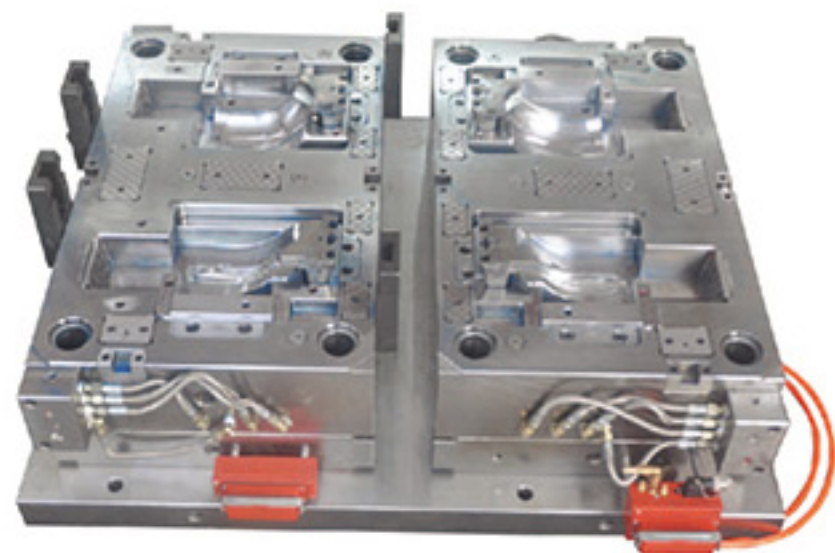

双色模具 / Bi-color Mould

我们专业设计和生产双色模具
Yuntian Mould is specialized in
designing and manufacturing Bi-color
Moulds

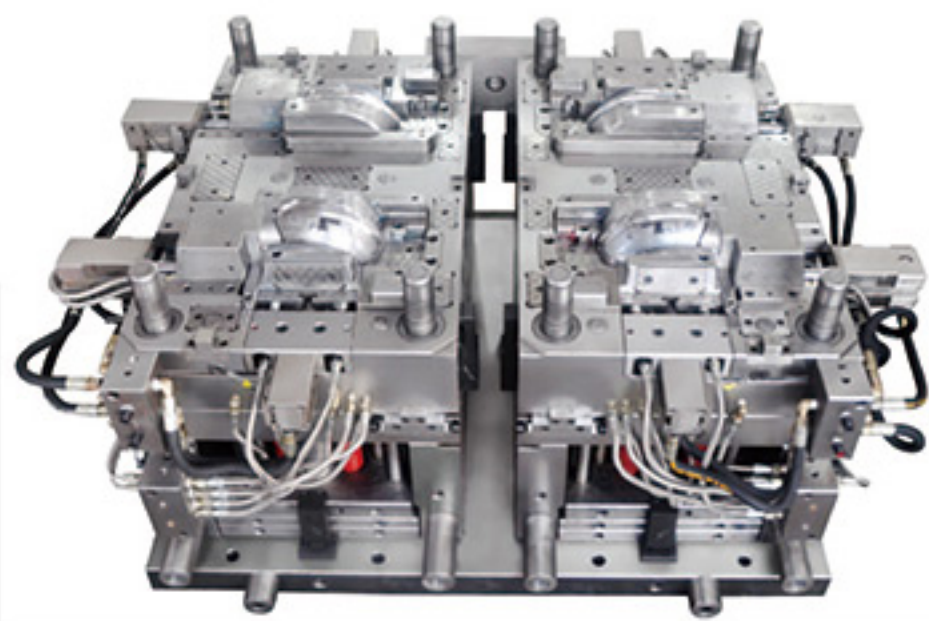
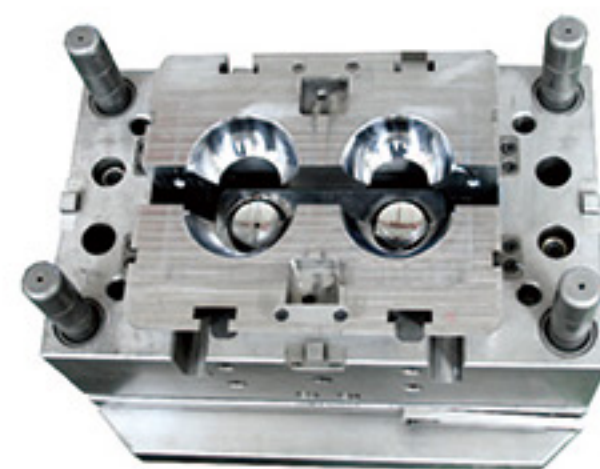
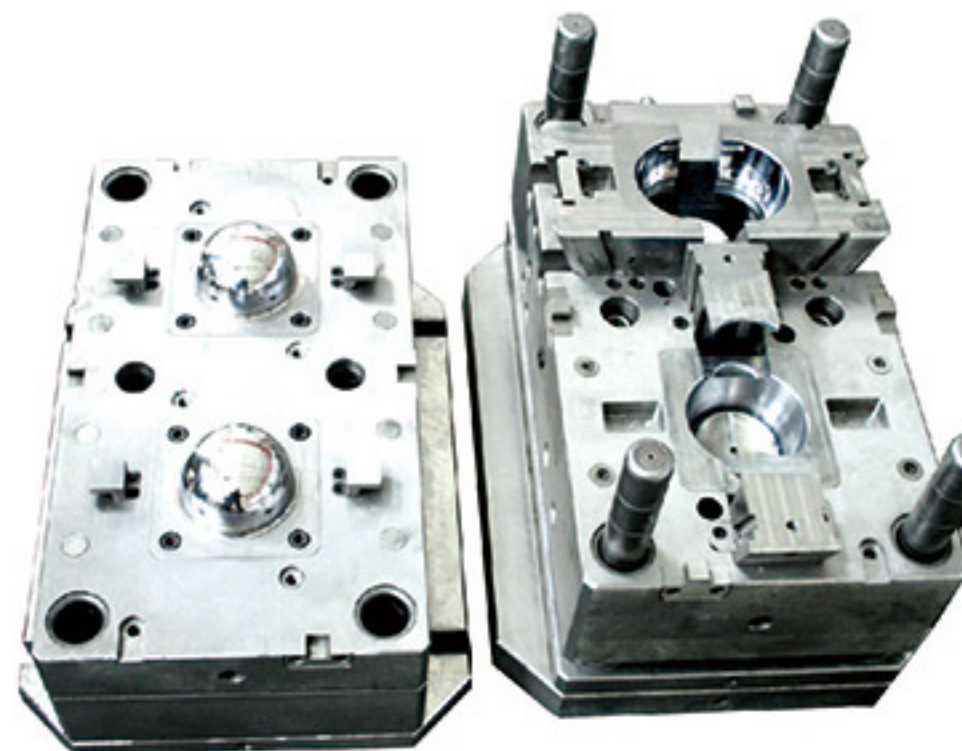

lamp mould

车灯模具

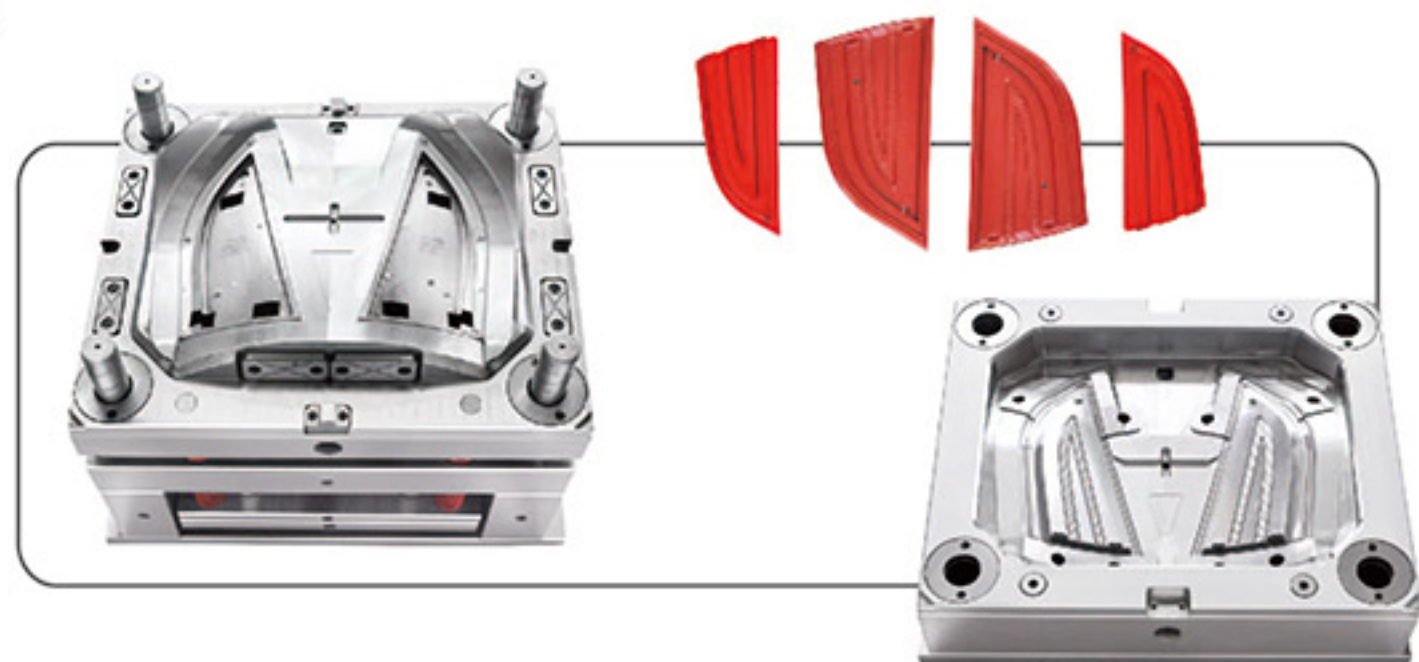
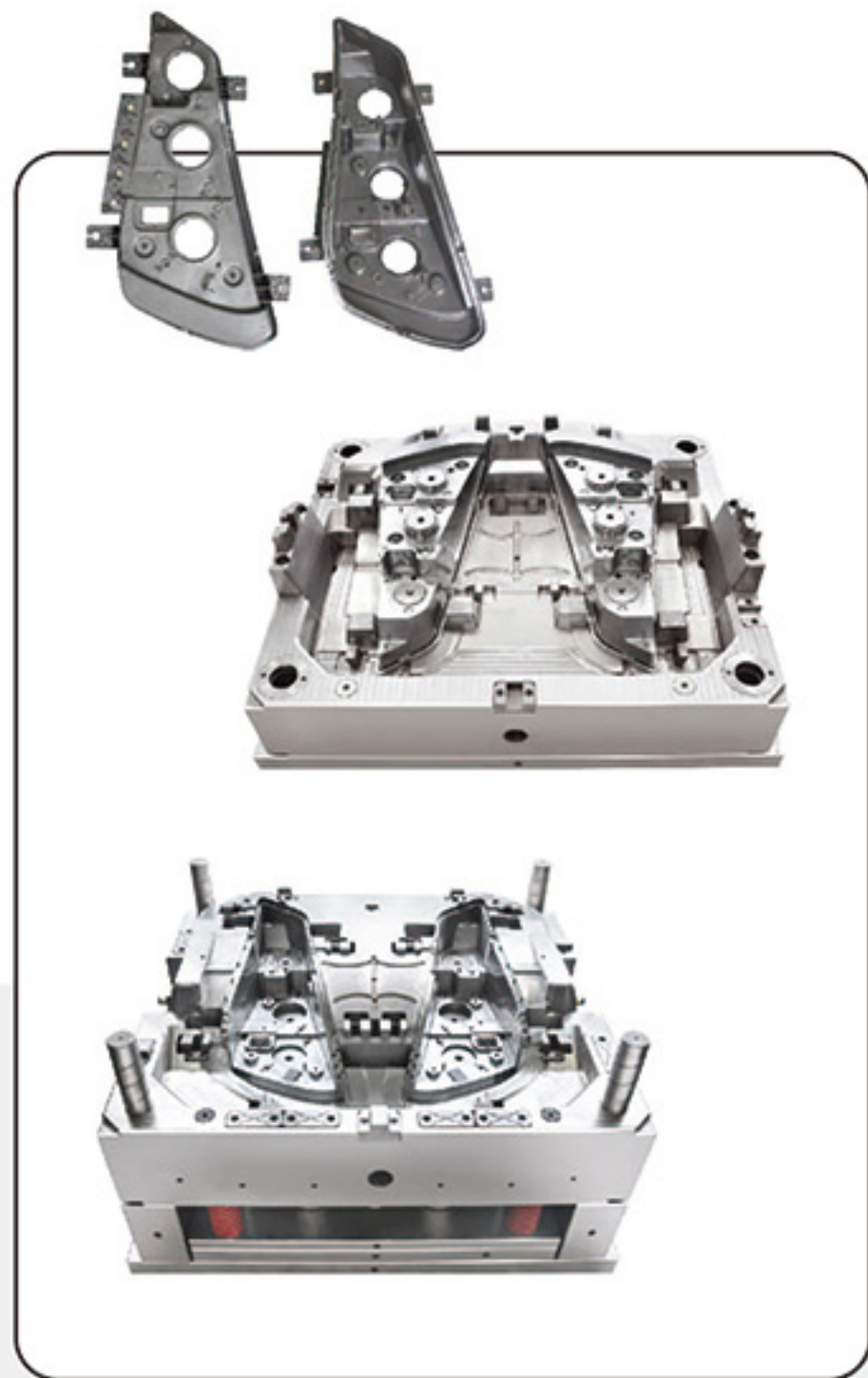

汽车模具 / Automotive

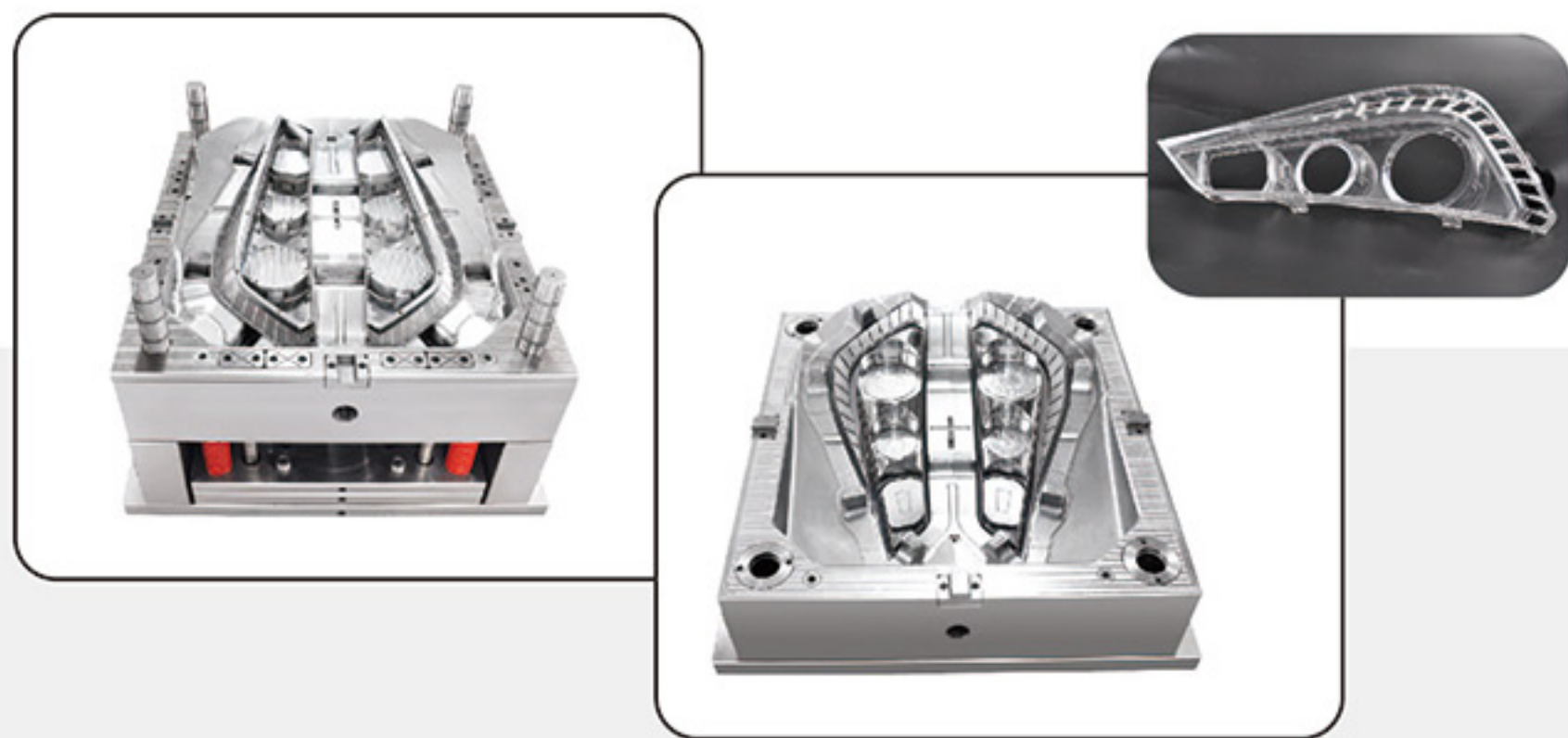

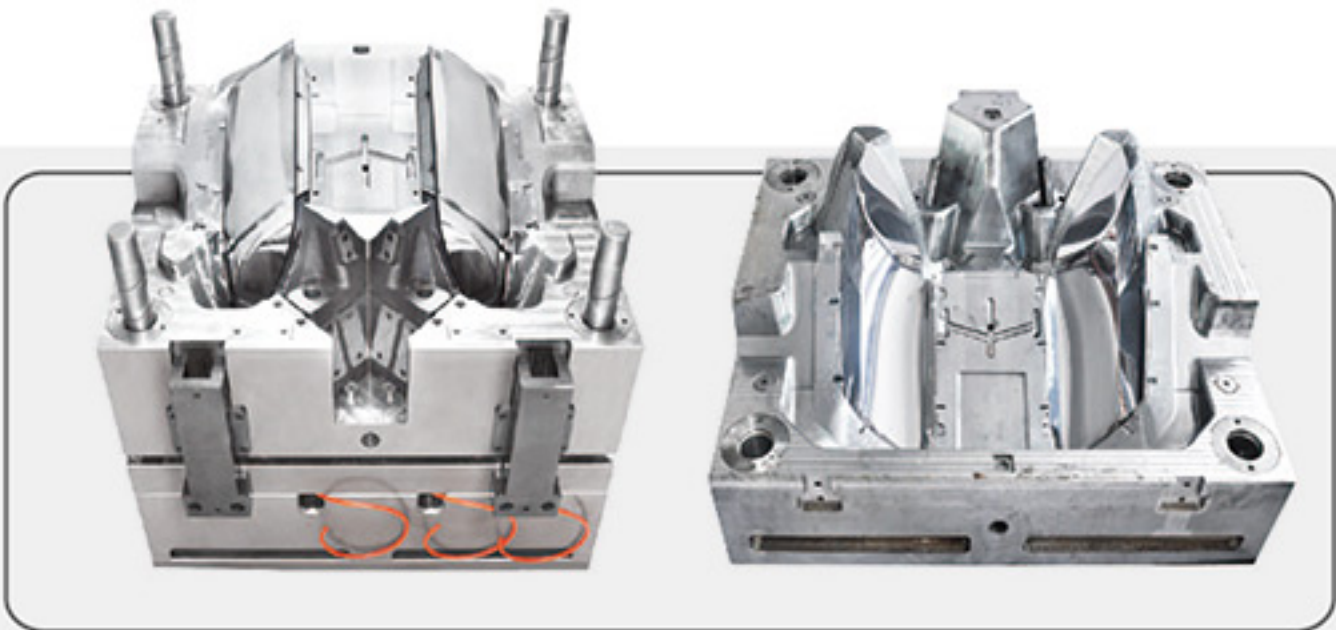
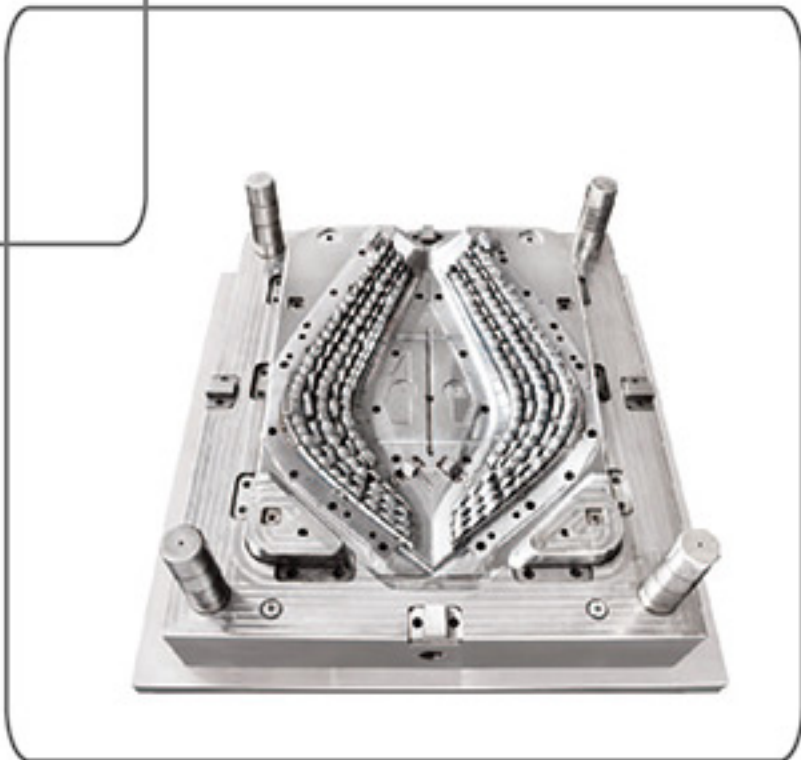
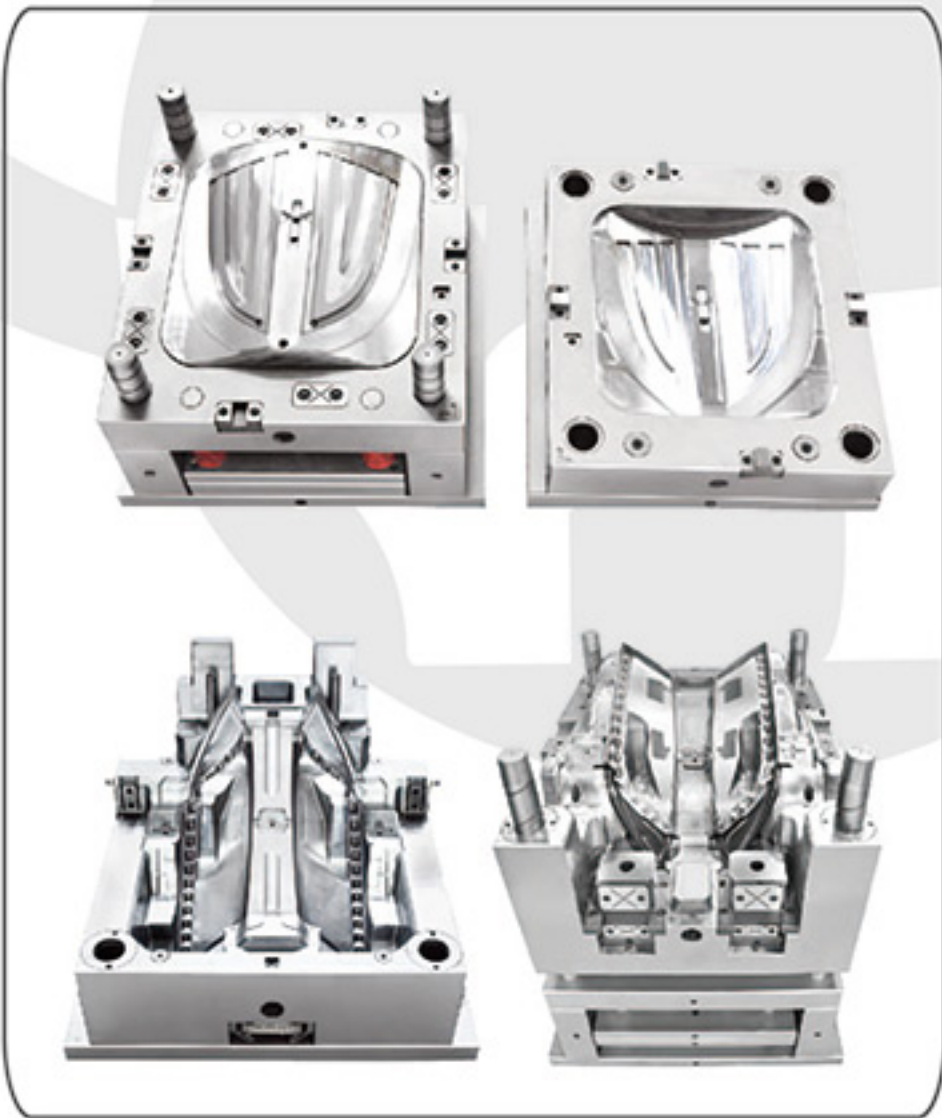
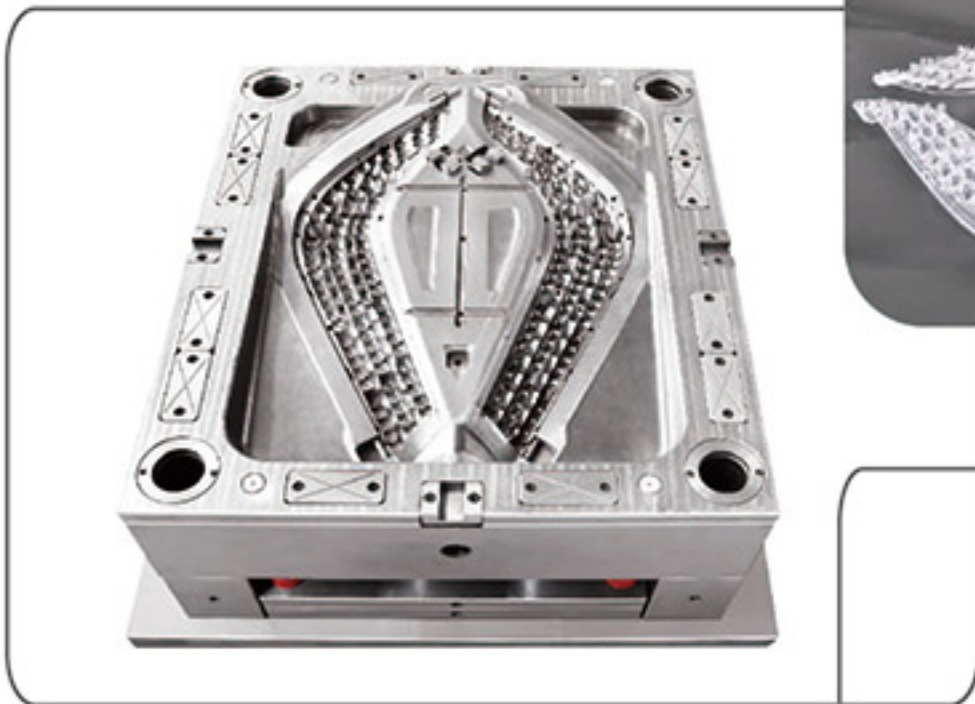
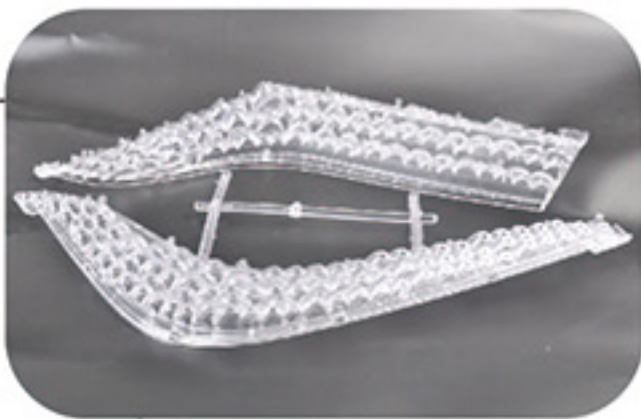

e Mould

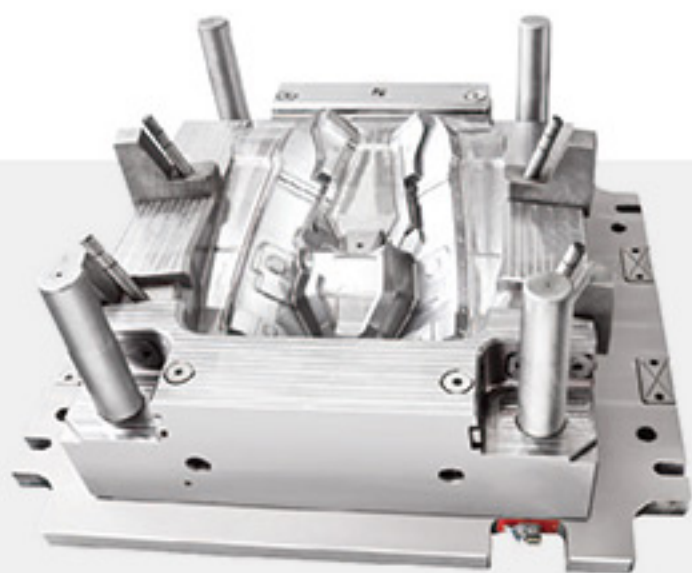

automobile mould

汽车模具



PUNTIAN MOULD & PLASTICS CO., LTD.

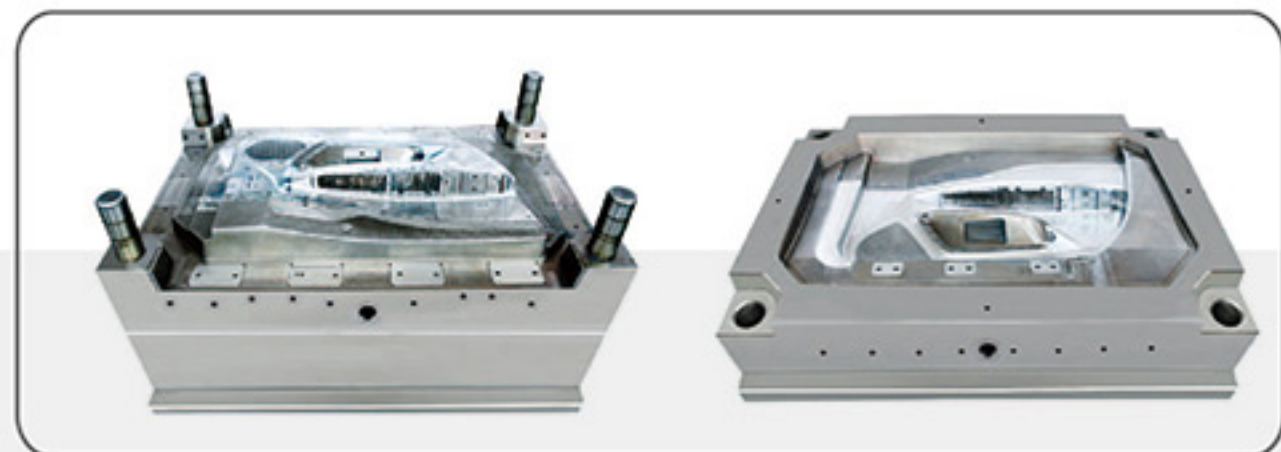
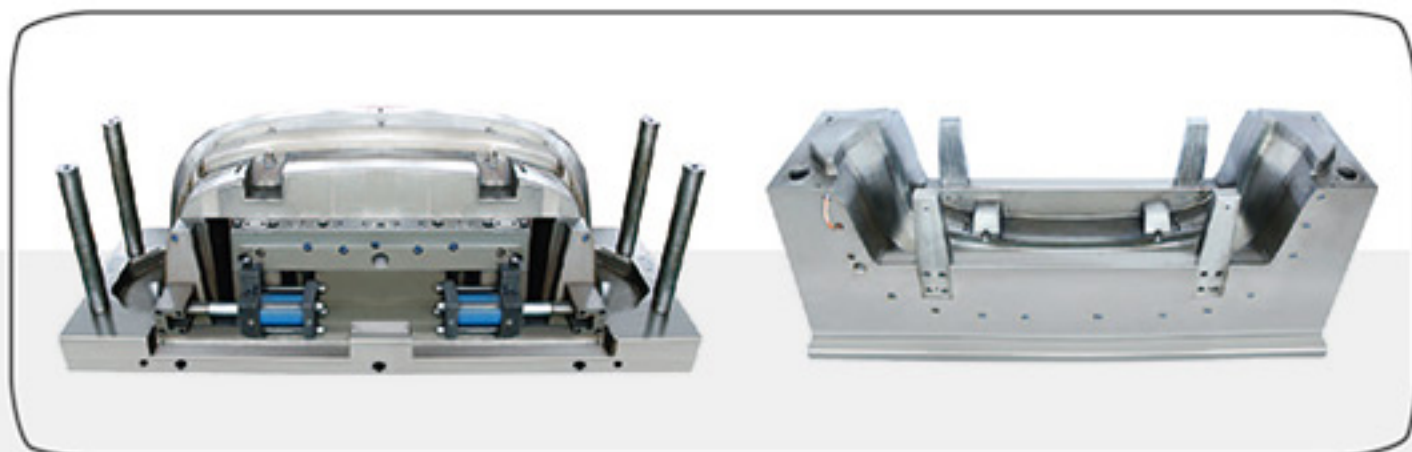
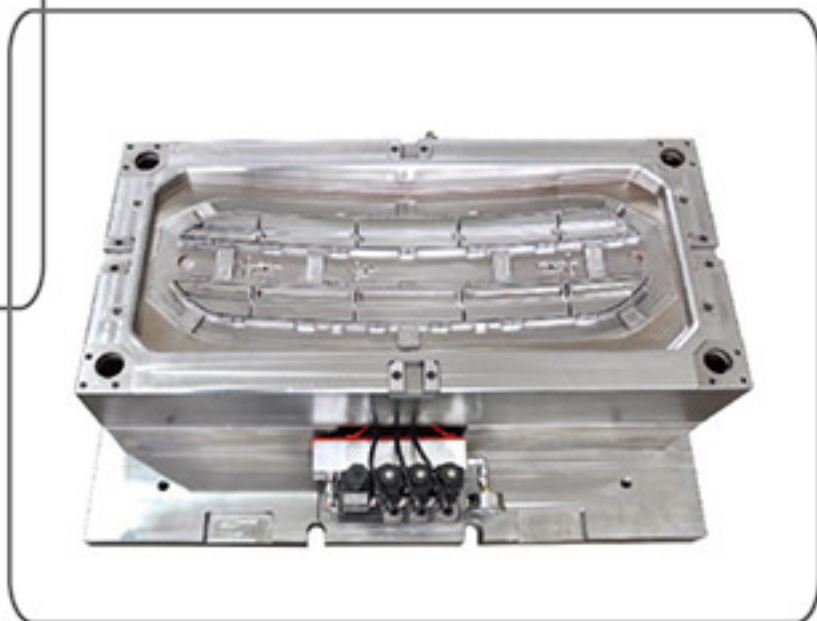

interior decoration mould

汽车内饰件模具

- 汽车装饰板模具 Decorative Plate Mould
- 汽车空虑器模具 Air Filter Mould
- 汽车内饰条模具 Interior Trim Mould

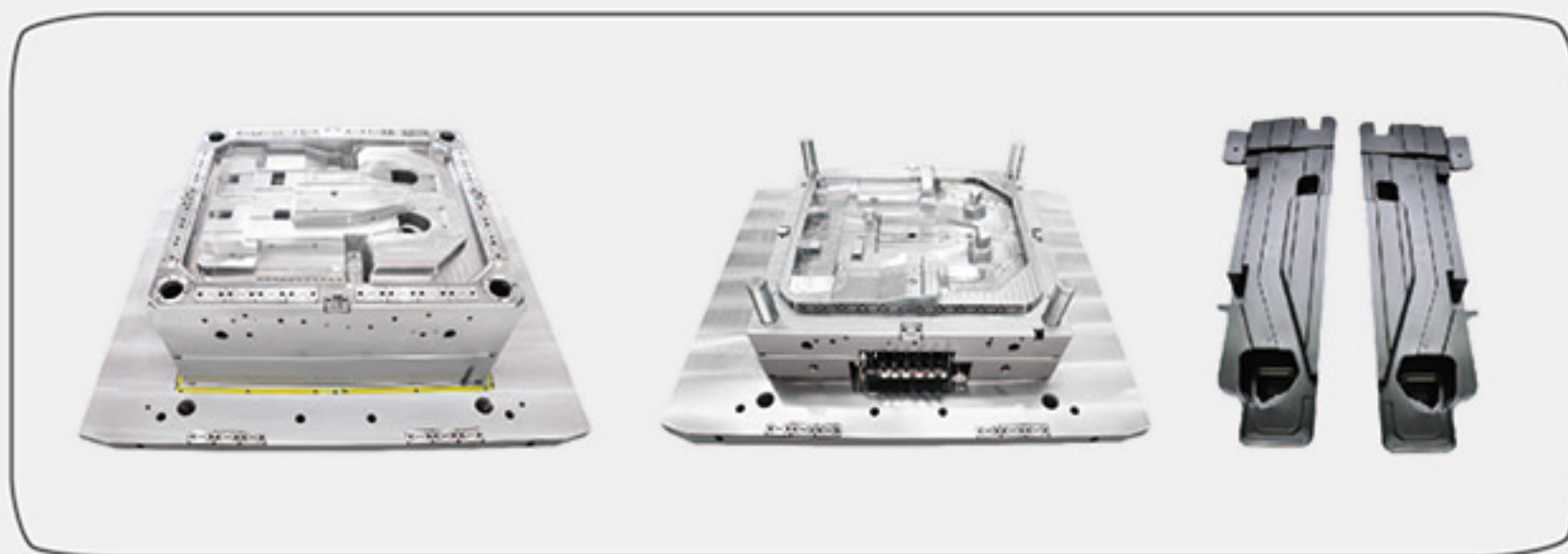

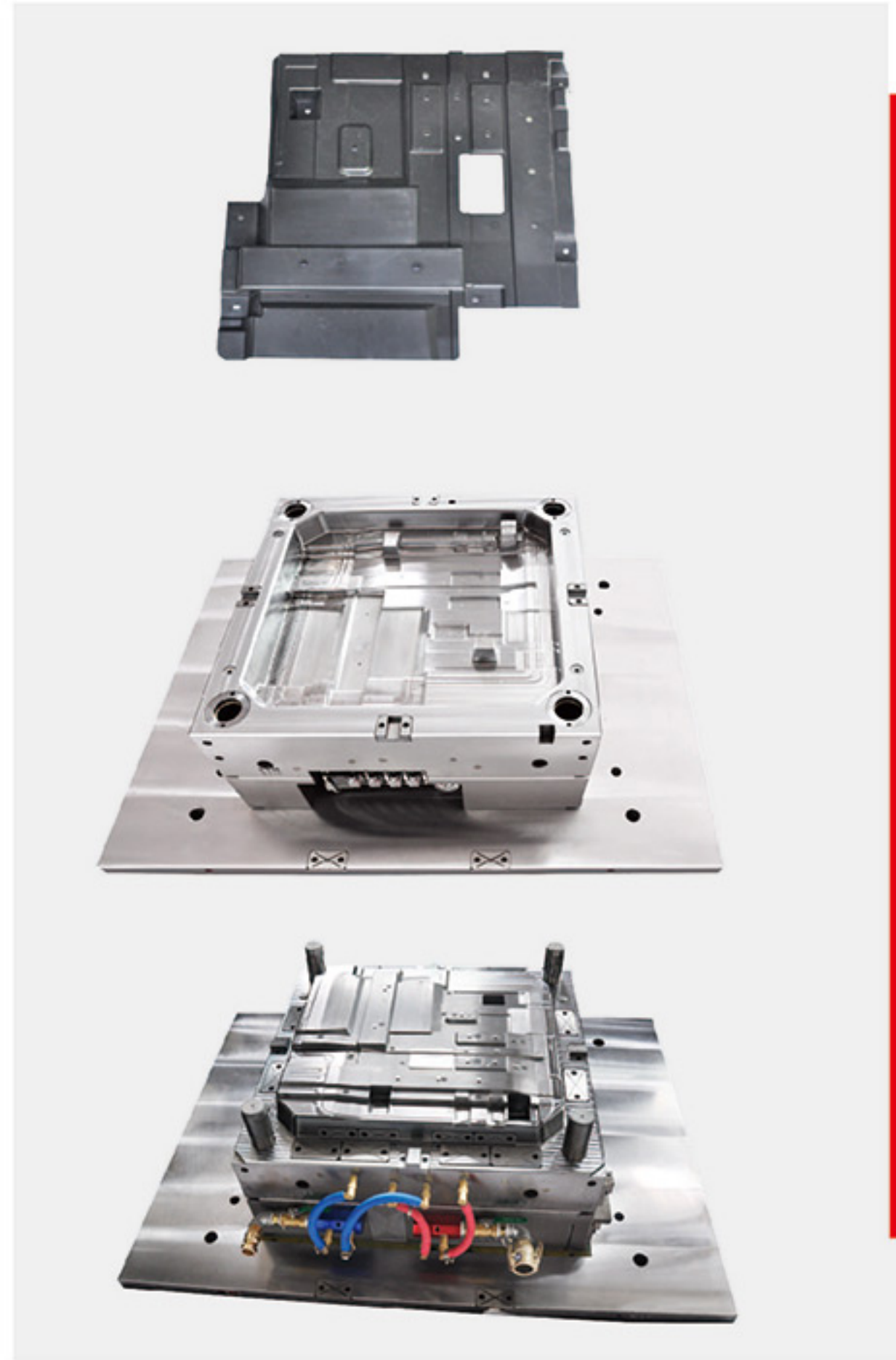
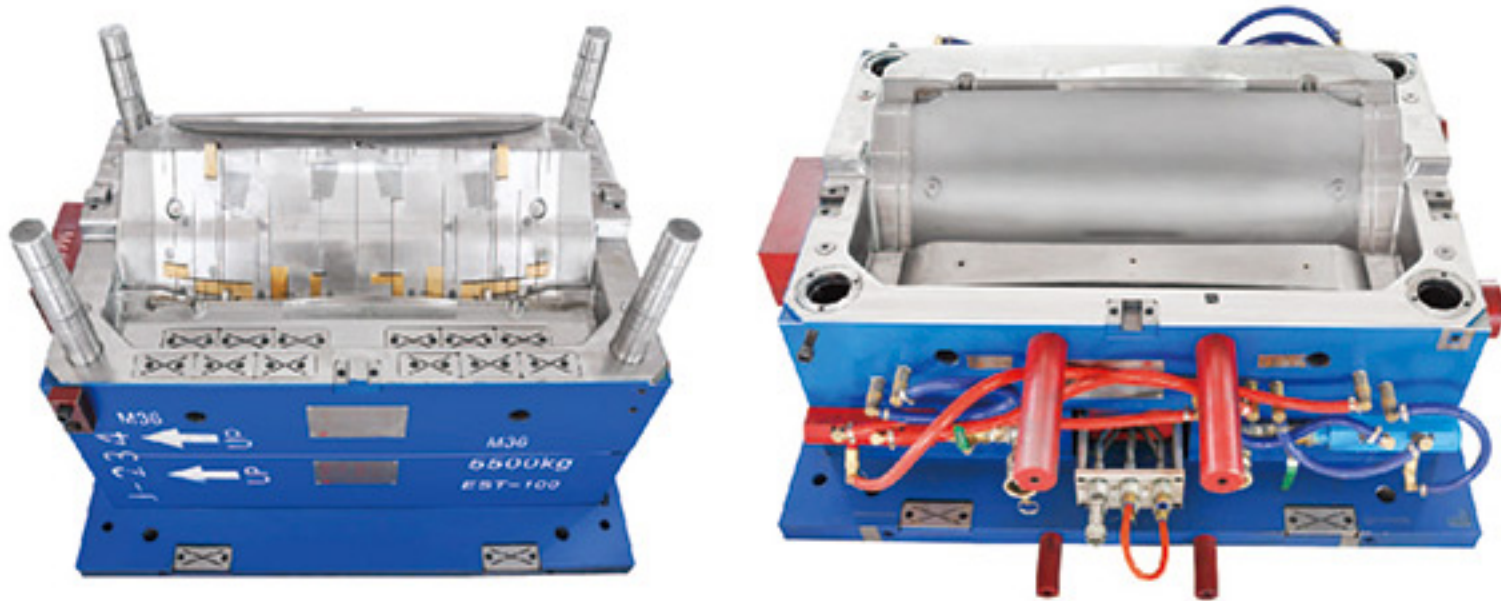
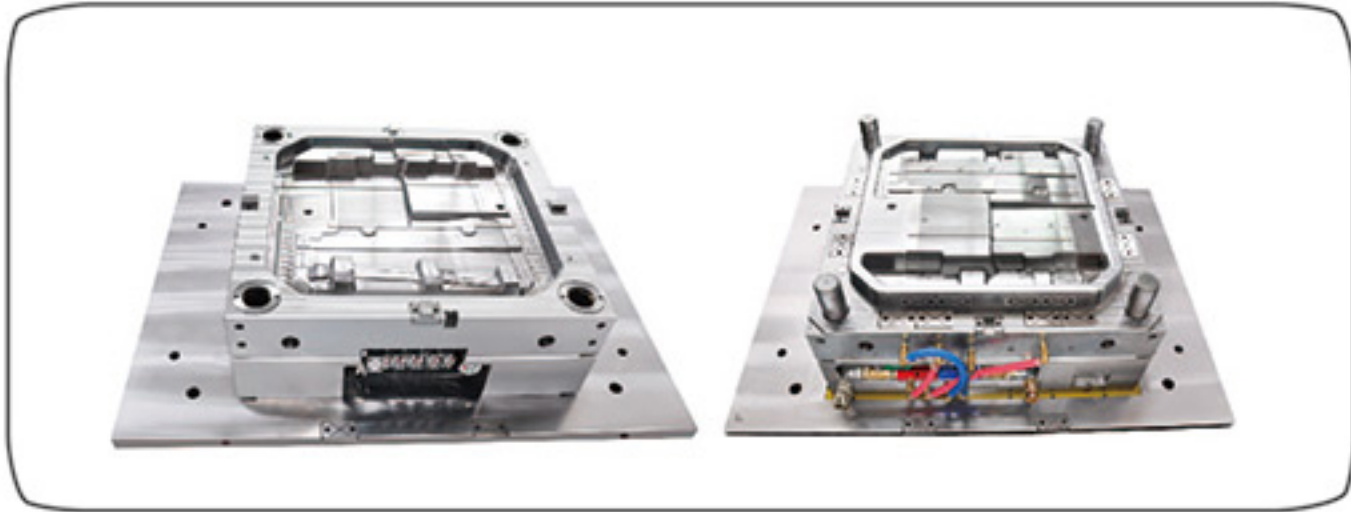
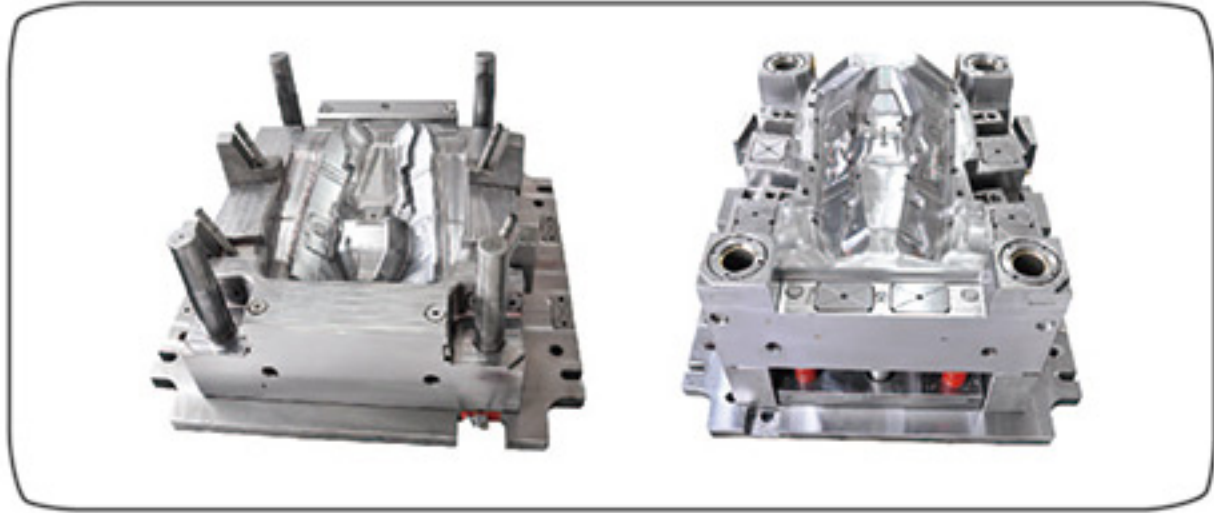



钢材编号	比较标准及特征	出厂状态及硬度	典型主要化学成份分析结果(%)
LKM 2083H	AISI 420 / DIN 1.2083	预硬至 HB 280 - 310	碳 (0.43) 铬(13.0) 锰(0.3) 钼(适量)
LKM 2311	AISI P20 / DIN1.2311	预硬至 HB 280 - 325	碳 (0.37) 铬(1.9) 锰(1.45) 钼(0.2)
LKM 2312	AISI P20+S / DIN 1.2312	预硬至 HB 280 - 325	碳 (0.37) 铬(1.9) 锰(1.45) 钼(0.2)
LKM 2316A	SUS 420 J2	退火至 HB 230(最高)	碳 (0.4) 铬(16.0) 镍(适量) 锰(0.5) 钼(1.0)
LKM 2316 ESR	JIS SUS 420 J2/DIN 1.2316	预硬至 HB 265 - 310	碳 (0.4) 铬(16.0) 镍(适量) 锰(0.5) 钼(1.2)
ASSAB 618, 618 HH			

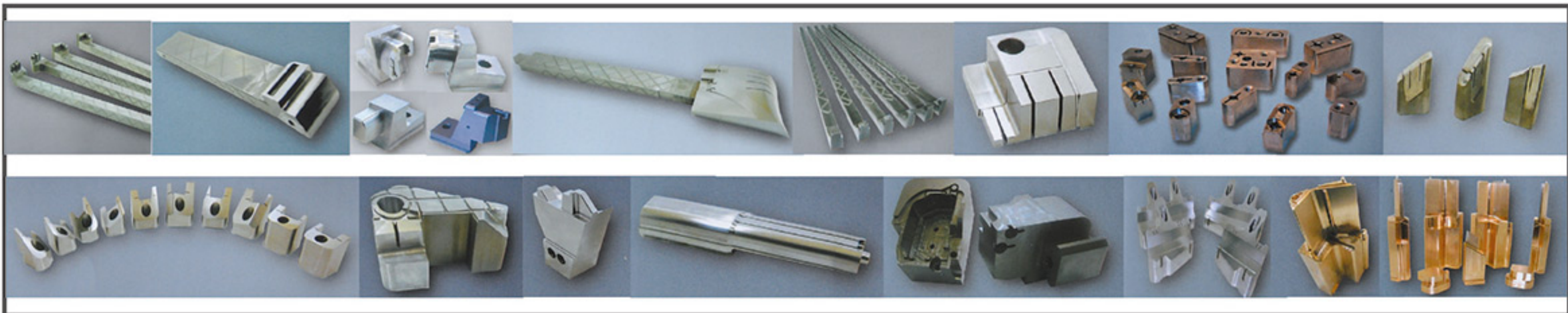

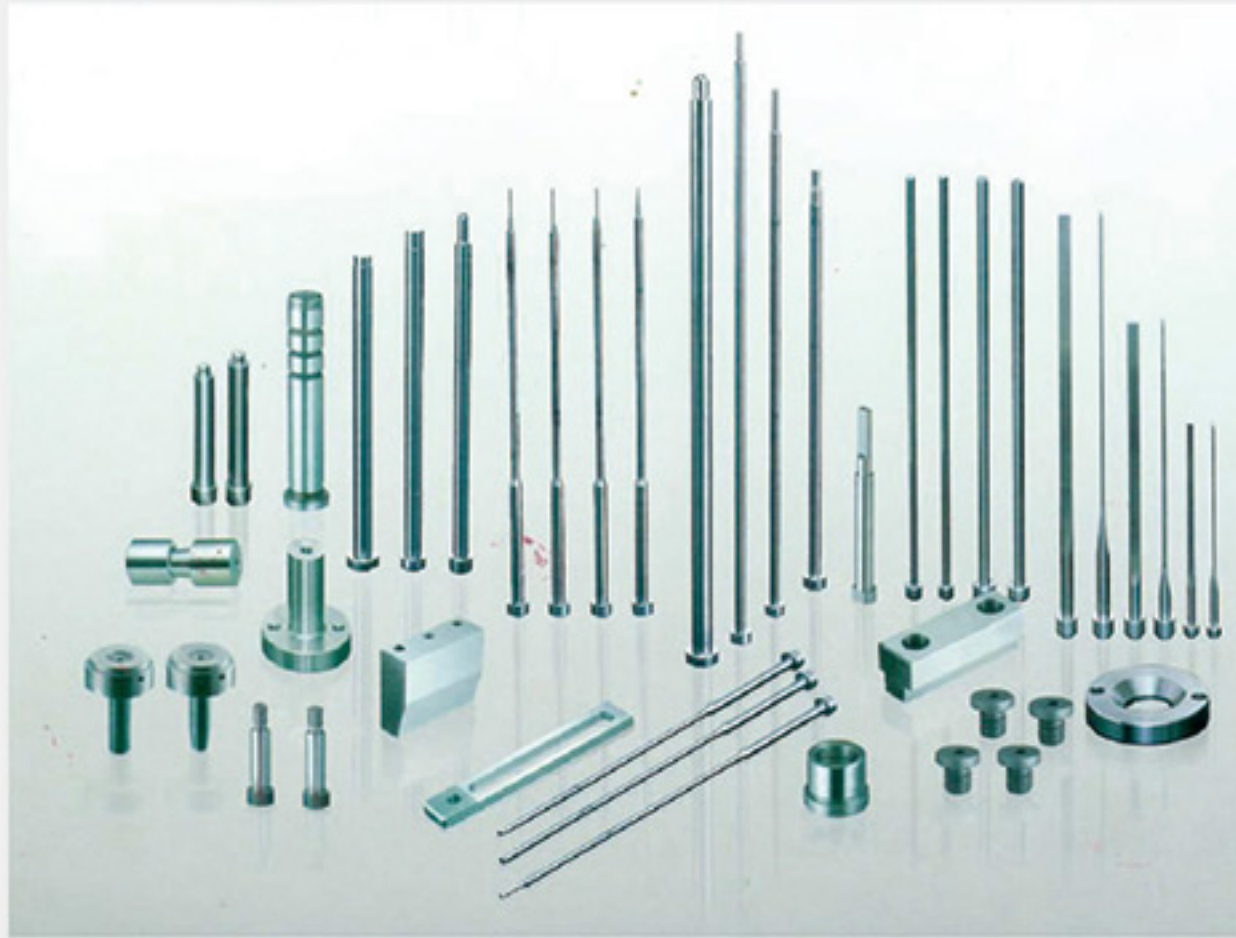

LKM

1.Mould Base Manufacturers:Lkm

<http://www.lkm.com.hk/>
Lung Kee Group, being one of the four largest mould base manufacturers in the world, has been ranked No.1 in its mould base sales quantity in Asia for years.

YUDO

2.Hot Runner:YUDO

<http://www.yudo.com/>
YUDO, a Hot Runner System supplier, was founded in 1980 by Francis Yu. Since then, we have focused on the quality of the systems and the customers' satisfactions. Our company is the leading manufacturer and distributor among Asia countries and the 4th largest company in the world's Hot Runner markets.

HASCO

2.Hot Runner:HASCO

<http://www.hasco.com/>
HASCO – our partner for intelligent hot runner solutions
competent - fast - reliable - worldwide
Unlike with a conventional tool, rigidifying runners are avoided in the processing of thermoplastics by using hot runner tools. This dispenses with all kinds of reworking. This makes the manufacture automatable and low-cost. The hot runner technology also guarantees the highest quality. Because the smelt can always be fed to the mould cavities at the optimum position and in optimum quality.

OUR SUPPLIER





台州市黄岩云天模塑有限公司

Taizhou Huangyan Yuntian Mould & Plastic Co., Ltd.

公司地址： 浙江黄岩西工业园区康强路三号

Address: 3# Kangqiang Road, West Industrial Zone, Huangyan, Taizhou, Zhejiang, China

Tel: 86-576-84289228

Fax: 86-576-84289229

Mobile: 86-13305862929

E-mail: info@yuntianmould.com hyzwjzwj@vip.163.com

Skype: yuntianmould

Website: www.yuntianmould.com